

EMAR Series Hazardous Location LED Luminaire

Product Description:

The EMAR-Series LED Luminaire can be used to replace HPS/MH jelly jar fixtures. The EMAR series is typically used in small spaces in which mounting heights range from 6-12ft. Commonly installed where moisture, dirt, dust, corrosion and vibration may be present, or NEMA 4X areas where wind, water, snow or high ambient temperatures can be expected. The fixture can be used in locations made hazardous by the presence of flammable vapors or gases or combustible dusts as defined by the NEC. The EMAR is standard with pendant mount and strut mounting clips.

Applications:

- Power Plants / Heavy Industrials Storage Facility
- Paper Mills / Wastewater Treatment Plants
- Loading Docks / Platforms / Shipyards
- Chemical Processing Facility
- Petrochemical Processing Facility
- Mining
- Ocean Marine
- LNG facilities
- Metal Industry
- Food & Alcohol Industry
- Remote sensors

Features:

- Heavy-duty and high impact resistance
- Replaceable Driver, LED board
- Dimmable and non-dimmable options available.
- Tempered glass lens standard with opal globe and guard option available for wider distribution and protection.
 - Angle Reflector
 - Dome Reflector
- Various mounting options include: pendant mount, wall mount, stanchion, or surface mount.
- Standard 120-277V, Available options include: 12-36VDC
- Operating Temperature: -40°C - 60°C (-40°F - 140°F)
- Housing: A383 Die Cast Aluminum
- Gasketing: Fluorosilicone Rubber
- Hardware: Stainless Steel
- Finish: Polyester Powdercoat
- Lens: Tempered Glass
- LED Chips: Philips
- Driver: Meanwell
- Surge Protection: 10KV
- Expected Life: Over 85,000 hrs.
- Rating: IP66 & IK10
- Color Rendering Index (CRI): 80



Product Dimensions

Flat Lens w/ Pendant Mount

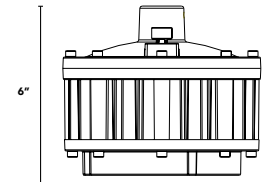

* Contact your local representative for angle or dome reflector dimensions

Drop Lens with Wire Guard w/ Pendant Mount

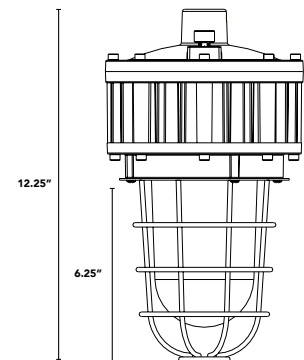

Ceiling Mounting Plate

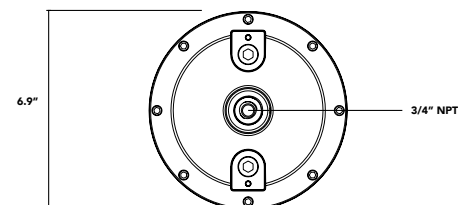

5 Year and 10 Year Warranties Available



BAA and TAA available. Contact factory for more information and pricing.

Ordering Information

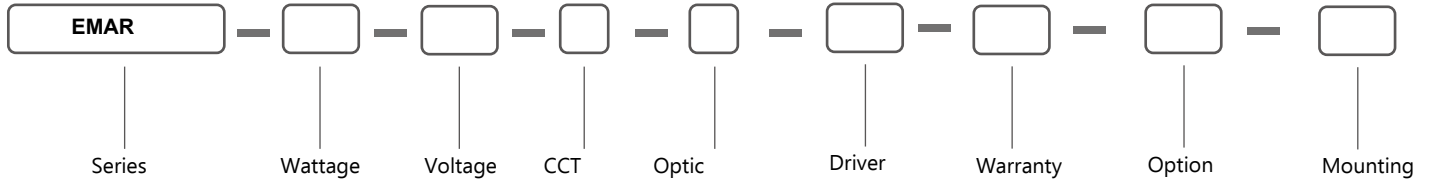

SERIES	WATTAGE	VOLTAGE	COLOR TEMP	OPTIC	DRIVER	WARRANTY
EMAR	1 = 10W 2 = 20W 3 = 30W 4 = 40W	A = AC100-277V C = 12-48VDC	S = 3000K I = 4000K C = 5000K K = 6000K	M = 40° N = 60° O = 90° P = 120°	D = 0-10V Dimming ND = No Dimming	5Y = Five Year Std 10Y* = Ten Year Warranty*

*Please contact factory for 10yr option.

OPTION

- EM = Emergency Battery Backup
- CG = Clear Globe
- FG = Frosted Globe
- WG = Wire Guard
- CGG = Clear Globe w/ Wire Guard
- FGG = Frosted Globe w/ Wire Guard
- DREF = Dome Reflector
- AREF = Angle Reflector
- S = Sensor (coming 2022)

- BAA** = Buy American Act Compliant**
- TAA** = Trade Agreements Act Compliant**

**Please contact factory for BAA and TAA options.

MOUNTING / ACCESSORIES

- OPEB = Junction Box
- OPCM = Ceiling / Surface Mounting & Junction Box: 3/4" NPT
- OPWA = 90° Wall Mount
- OPWA25 = 25° Wall Mount & Junction Box: 3/4" NPT
- OPWA90 = 90° Wall Mount & Junction Box: 3/4" NPT
- OPPS25 = 25° Pole Mount: 1-1/2" NPT
- OPPS90 = 90° Pole Mount: 1-1/2" NPT

*STANDARD STOCK ITEMS ARE:

- 5000K CCT
- 100-277V
- Non-Dimmable
- W/Globe and Wire Guard

Compliance

UL 844 Hazardous Locations North America

- Class I, Division 1, Groups C, D
- Class I, Division 2, Groups A, B, C, D
- Class II, Division 1, Groups E, F, G
- Class II, Division 2, Groups E, F, G
- Class III

Marking Marine

- UL1598,
- UL1598A
- ABS

Other Markings / Standards

- IP66
- IK10

Lumen Chart

	5000K
10W	1,400lm
20W	2,800lm
30W	4,200lm
40W	5,600lm
50W	7,000lm

Photometric

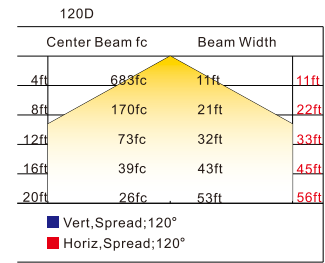
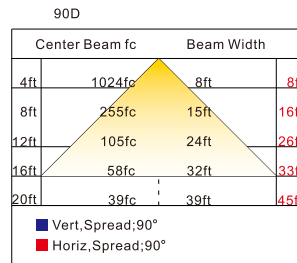
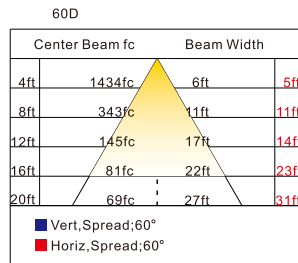
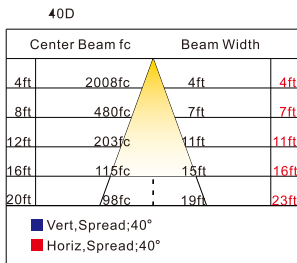

Mounting Accessories

OPEB: Junction Box

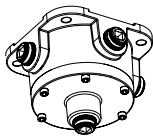

OPWA25: 25° Wall Mount & Junction Box

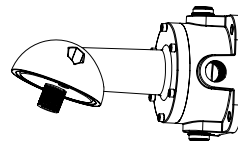

OPWA90: 90° Wall Mount & Junction Box

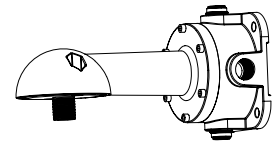

OPWA: 90° Wall Mount

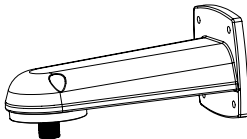

OPPS25: 25° Pole Mount

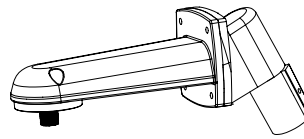

OPPS90: 90° Pole Mount

