

EUDS-TW24

24"x24" Architectural LED Pendant Luminaire

Stylish architectural solution which creates stunning forms only 1.5" high. It combines clean lines and thin, square forms to enhance the decor. The unique design is nearly transparent luminaire when off and excellent uniformity and efficiency when on, reaching 55% downlighting and 45% uplighting distribution

Features:

- Semi-transparent optics
- CCT adjustable 3000K/ 3500K/ 4000K
- Wattage selectable: 100lm/w
- 24"x24"
- 55% downlight and 45% uplight distribution
- External driver with 0-10V dim, dim to 1%

Model#	Dimension	Wattage Selectable	Efficacy	Lumens
UDS-TW24	24"x24"	50W/40W/30W	100lm/w	Up to 5000lm

All efficacy is ±5% base on different CCT. Check the IES file to gain the accurate data .

Optics: High precision light guide made of PMMA material, allows distribution of controlled light to create 45% uplight, 55% downlight light distribution.

Finish: Extruded aluminum housing. Powder coat black or white finish.

ELECTRICAL:

Driver Dimming: External, class 2, high efficiency LED driver. Standard constant current electronic driver with 0-10V dimming, dim to 1% . Tested Dimmers : LEVITON DD710, LUTRON NTSTV-DV, LEGRAND RH4FBL3PTC, LUTRON DVSTV, LEVITON IP710.

THD: <20%

Power Factor: >0.9

Input Voltage: 120-277V Standard .120-347V * optional

LED SYSTEM:

CRI: Minimum 80 color rendering index

CCT: Adjustable from 3000K, 3500K and 4000K with a great color consistency.

LED: Life minimum 50,000h with 87.8% of lumen maintenance in 25°C ambient temperature, in compliance with IES LM-80 testing measurements. Aluminum housing acting as the heat sink to maximize life.

Thermal Management Environment: Damp rated in operating ambient temperatures of -20~40°C.

Approvals:

- cULus listed for damp locations
- 5 years limited warranty

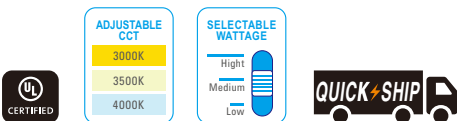

DIMENSIONS

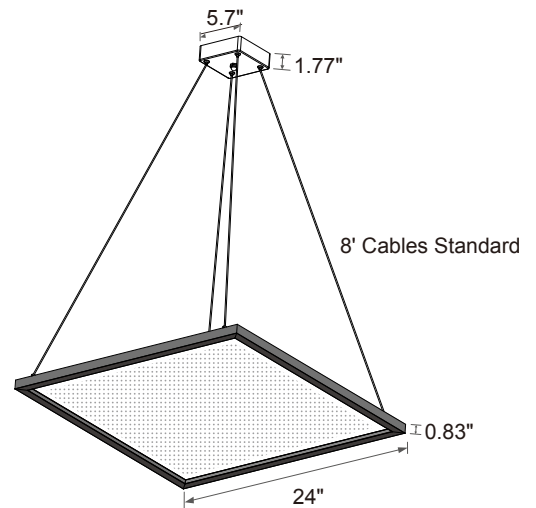

Mounting: Pendant

Dry ceiling or T-Grid ceiling compatible.

Cable lengths of 8ft is standard, 12ft or others are available.

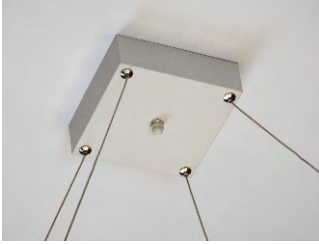

Dry Ceiling / Off Grid

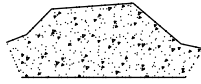

"Various Hard Ceilings" (Mount to J-box)

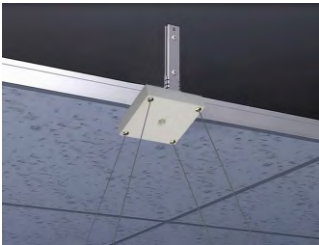
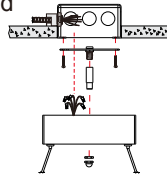

Drop Ceiling / On Grid

Suspending the luminaire in the T-grid. Compatible for various T-grid, including 9/16" Flat, 9/16" Slot, 15/16" Flat.

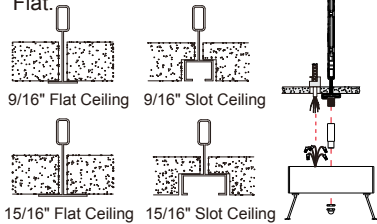

*Please see the installation instruction for more details.

Optional Function

Emergency Option



Optional low voltage 8W emergency LED driver EM-L0854-LBF can be provided. When AC power fails, it immediately switches to the emergency mode, operating for lighting up to 120 minutes. When AC power is restored, it automatically returns to the charging mode which meets critical life-safety lighting requirements. For more info or spec sheet, please visit our website or contact sales.

Emergency Lumen Output:

FIXTURE EFFICACY OUTPUT POWER 8W

100lm/w

800 Lumens

**Make to Order means additional cost and/or lead time on customized fixtures may apply. Some fixtures require an MOQ. Please contact your sales rep for more information.*